

C-Frame MKIV - Series Circuit Breakers



The C-Frame MKIV is the most traditional distribution and equipment protection circuit breaker and is available in 1 to 4 poles. This front mounted circuit breaker is available for panel mounting, and is available with a standard handle and rocker handle.

The C-Frame MKIV circuit breaker is used in power distribution units, lighting control and in other equipment.

Features

- AC and DC circuit breaker
- Hydraulic-magnetic technology
- 100% rating capability independent of ambient temperature
- Up to four poles
- VDE, EAC and CCC approved, CE certified
- UL compliant (Listed / recognised)
- Ratings 0.1 A to 50 A (Specific certifications)
- Precision tripping characteristics
- Wide range of circuits, mountings, terminations and time delays
- Two colour handle indication (Two tone flush rocker)
- Optional auxiliary switch and trip alarm

Applications

- Telecom DC Power distribution
- UPS equipment
- Mobile power generation equipment
- Alternative energy equipment
- Lighting control

Approvals

The C-Frame MKIV is CE certified and carries various approvals such as VDE, cURus, EAC and CCC. It is also recognised to UL 1077, UL 1500 and UL 508, and listed to UL 489 and UL 489A.



(UL489A)



(UL489)

(CSA C22.2 No. 5-09)



(UL1077)

(CSA C22.2 No. 235-04)



(DIN / EN / IEC 60934)



(GB17701)



(IEC 60934)



Hydraulic-Magnetic Circuit Breakers 100% rated, unaffected by ambient temperature

C-Frame MKIV - Series Circuit Breakers

Technical Data

Product Type	C-Frame MKIV
Ambient Operating Temperature	-40 °C to +85 °C
Endurance	10000 operations DC, 6000 operations AC (IEC60934 Clause 9.11)* 10000 operations, 6000 with current, 4000 without current (UL489 Clause 7.1.5)* As per UL489 or minimum of 1000 operations with current (UL489A Clause 12)*, 6000 operations with current (UL1077 Clause 22)*
Dielectric Strength	1000 - 2000 Vac for one minute (Clause 9.7)* 1000 Vac plus twice the rated voltage for one minute (UL489, Clause 7.1.9; UL489A Clause 8, UL1077 Clause 23)*
Weight	70 g per pole (unpacked)
Altitude	Certification tests done at altitude ≈ 2000 metres. Will operate at higher altitudes.
Shock	100 G to MIL-STD-202G, test method 213B, test condition 1
Vibration	10 G to MIL-STD-202G test method 204D, test condition A
Flammability	I2 - No ignition at 850 °C with an oxygen index of ≥ 32
Toxicity	F1 - Smoke index of ≤ 20 which determines the fume class
Pollution Degree	PD2 - Normally only non-conductive pollution occurs. Temporary conductivity caused by condensation is to be expected.

* Refer to the standard for details

Product Type	Circuit Breaker	Circuit Breaker	Circuit Breaker	Circuit Breaker
Approvals	UL 489	UL 489A	UL 1077	UL 1500
Number of Poles	1, 2	1, 2	1 - 4	1, 2
Maximum Voltages	120 Vac, 120 / 240 Vac	80 Vdc	240 Vac, 277 Vac 80 Vdc	120/240 Vac 65 Vdc, 32 Vdc
Current Ratings	0.05 - 20 Aac	0.05 - 50 Adc	0.05 - 50 A (AC & DC)	0.05 - 50 A (AC & DC)
Interrupting Capacity	5 kA	5 kA	2 kA (AC), 7.5 kA (DC)	1.5 kA, C1 & 3 kA, C1

Product Type	Circuit Breaker	Switch
Approvals	DIN/EN/IEC 60934, CE, UKCA, GB17701	UL 508
Number of Poles	1 - 4	1 - 4
Maximum Voltages	240 Vac, 80 Vdc	240 Vac, 277 Vac, 80 Vdc
Current Ratings	0.05 - 50 A (AC & DC)	50 A
Interrupting Capacity	2 kA (AC), 4 kA (DC)	-

Verify approvals for specific ratings in accordance with the relevant test certificates.

Torque Table

Description	Size	Torque Value
Front Inserts	M3	0.5 - 0.8 N.m
	6 - 32	5 - 7 lbf.in
Rear Screws	M5	1.7 - 2.3 N.m
	10 - 32	15 - 20 lbf.in

C-Frame MKIV - Series Circuit Breakers

Ordering Information

Group 1: Frame	Code	Description	Comments			
	C	C-Frame				
Group 2: Type	Code	Description	Comments			
	B	C-Frame MKIV				
Group 3: Mounting	Code	Description	Comments			
	2	Front mount round aperture, fleet	Warning: Maximum penetration depth into the mounting screw is 5.4 mm, 0,21 inch			
	3	Snap-in mount edges bevelled, without handle guards				
	B	Snap-in mount edges flush, without handle guards				
	C	Front mount round aperture, dome	Required for UL listed products. Maximum penetration depth into the product by the mounting screw is 5.4 mm, 0,21 inch			
	S	Front mount rectangular aperture flush rocker handle	Warning: maximum penetration depth into the mounting screw is 5.4 mm, 0,21 inch			
Group 4: Handle Type	Code	Description	Comments			
	A	Standard Toggle Handle				
	C	Cut off handle - Single Pole Only				
	H	Flush Rocker Handle, One Colour	Use with Group 3, code S. Reduced Handle up to three pole only. One colour handle			
	M	Flush Rocker Handle - Two Tone	Use with Group 3, code S. Reduced Handle up to three pole only			
	Q	Flush rocker handle, Push to Reset; Use Test button to switch OFF. One Colour	Use with Group 3, code S. Reduced Handle up to three pole only. One colour handle			
	R	Flush rocker handle, Push to Reset- Two Tone; Use Test button to switch OFF.	Use with Group 3, code S. Reduced Handle up to three pole only. Two Tone			
	Y	No handle, for reduced handle versions				
Group 5: Termination	Code	Description	Comments	Code	Description	Comments
	CX	Quick connect terminal (0.8 mm x 6.35 mm)	30 A max	42	Screw terminal 30° bent, bus connected (M5 or 10-32)	50 A max
	22	Screw terminal, bus connected (M5 or 10-32)	50 A max	52	Screw terminal 30° bent, upturned ears (M5 or 10-32)	50 A max
	32	Screw terminal, upturned ears (M5 or 10-32)	50 A max			
Group 6: Number of Poles	Code	Description	Code	Description		
	1	1 pole metric	A	1 pole imperial		
	2	2 pole metric	B	2 pole imperial		
	3	3 pole metric	C	3 pole imperial		
	4	4 pole metric	D	4 pole imperial		
Group 7: Rated Voltage and Frequency - Main Circuit	Code	Description	Comments			
	J	120Vac, 240Vac (Applicable to Listed Single Pole Products)	120Vac UL489, 240Vac IEC60934			
	K	240Vac; 277Vac (Applicable to Recognized Single Pole Products)	240Vac UL1077, IEC60934; 277Vac UL1077			
	L	80V DC/277V 50/60Hz	50 / 60 Hz AC / DC version. With AC and DC curves			
	M	80V DC/240V 50/60Hz	50 / 60 Hz AC / DC version. With AC and DC curves			
	N	80V DC				
	P	65V or 80V DC / 120V 50/60Hz	Note: 65Vdc UL1500 & 80Vdc UL1077			
	S	120/240Vac, 240Vac (Applicable to Listed Multipole Products)	120/240Vac UL489, 240Vac IEC60934			

C-Frame MKIV - Series Circuit Breakers

Ordering Information

	Code	Description	System	Pulse Tolerance (X In)	Code	Description	System	Pulse Tolerance (X In)	
	Group 8: Time Delay Characteristics (Curve Details); Pulse Tolerance at 10 ms	AD	Long delay 50 / 60 Hz AS & dual rated	AC and DC	8 - 10	CH	Short delay 50 / 60 Hz CS & high inrush	AC	12 - 15
BD		Medium delay 50 / 60 Hz BS & dual rated	AC and DC	8 - 10	AS	Long delay 50 / 60 Hz	AC or DC	8 - 10	
CD		Short delay 50 / 60 Hz CS & dual rated	AC and DC	6 - 8	BS	Medium delay 50 / 60 Hz	AC or DC	8 - 10	
AE		Long delay 50 / 60 Hz AH & inertia delay	AC	28 - 35	CS	Short delay 50 / 60 Hz	AC or DC	6 - 8	
BE		Medium delay 50 / 60 Hz BH & inertia delay	AC	28 - 35	AW	Long delay 50 / 60 Hz AD & inertia delay	AC and DC	16 - 20	
CE		Short delay 50 / 60 Hz CH & inertia delay	AC	21 - 35	BW	Medium delay 50 / 60 Hz BD & inertia delay	AC and DC	16 - 20	
AI		Long delay 50 / 60 Hz AS & inertia delay	AC or DC	16 - 20	CW	Short delay 50 / 60 Hz CD & inertia delay	AC and DC	12 - 15	
BI		Medium delay 50 / 60 Hz BS & inertia delay	AC or DC	16 - 20	H3	Short delay	DC	6 - 8	
CI		Short delay 50 / 60 Hz CS & inertia delay	AC or DC	12 - 15	OP	Instantaneous trip 50 / 60 Hz	AC and DC	None	
AH		Long delay 50 / 60 Hz AS & high inrush	AC	16 - 20	OX	Switch 50 / 60 Hz	AC and DC	-	
BH		Medium delay 50 / 60 Hz BS & high inrush	AC	16 - 20					
Group 9: Rated Current (Main Circuit) - Examples Only - Specific Amp Ratings Possible		Code	Description	Comments					
	XXXX	Not applicable	Examples only - specific Amp ratings possible from 0.5 A - 50 A						
	050M	50 mA							
	100	1 A							
	1000	10 A							
	5000	50 A							
Group 10: Circuit Configuration (Circuit Breaker's Internal Construction)	Code	Description	Comments						
	AX	Switch	See group 12 for voltage options						
	BX	Circuit breaker (Series trip, current coil in series)							
	DX	Switch with relay trip voltage sensing, centre terminal construction, four terminal							
	GX	Circuit breaker with dual control - shunt trip construction (3rd terminal) 3rd terminal close to load side							
	HX	Circuit breaker with dual control, relay trip construction (4th terminal)							Curves AH, BH, CH, AE, BE, CE not possible. See group 12 for voltage options
	JX	Switch with auxiliary switch							
	KX	Circuit breaker (Series trip), with auxiliary switch							
Group 11: Auxiliary and Alarm Switches	Code	Description							Comments
	X	Not applicable	DB3-Gold Tips, Equally spaced terminals, 2.75 mm (EN61058 0.1 A @ 250 Vac & 0.1 A @ 80 Vdc and UL1054 0.1 A @ 125/250 Vac & 0.1 A @ 30 Vdc & 0.3 A @ 60 Vdc)						
	A								
	B	DB2-Silver Tips, Equally spaced terminals, 2.75 mm (EN61058 10 A @ 250 Vac & 0.1 A @ 80 Vdc and UL1054 10 A @ 125/250 Vac)							
Group 12: Voltage and Current Ratings for Dual Control, Shunt and Relay Trip Construction	Code	Description	Code	Description	Code	Description	Code	Description	
	XX	Not applicable	A5	220 - 240 Vac 50 / 60 Hz	B1	24 Vdc	B3	80 Vdc	
	A4	110 - 125 Vac 50 / 60 Hz	B0	12 Vdc	B2	48 Vdc	Recommended pulse duration: 20 ms to 40ms		
Group 13: Terminal for Shunt Relay and Dual Control Construction	Code	Description	Comments						
	X	Not applicable	Screw terminals M5 or 10 - 32						
	B								
	C	Quick connect terminals (0.8 mm x 6.35 mm)							

C-Frame MKIV - Series Circuit Breakers

Ordering Information

Code	Description	Comments
Group 14: Voltage for Illuminated Rocker		
Code	Description	Comments
X	Not applicable	
Group 15: Terminal for Illuminated Rocker		
Code	Description	Comments
X	Not applicable	
Group 16: Handle Colour		
Code	Description	Comments
B	BLACK HANDLE, WHITE MARKING.	Black Colour Not available on the Two Tone Flush Rocker
F	GREY / BLACK MARKING.	
G	GREEN HANDLE, WHITE MARKING (Used with Code H or Q on group 4) OR BLACK HANDLE, GREEN INDICATOR AND MARKING (Used with Code M or R ON group 4 - Two Tone)	Refer to Group 4
R	RED HANDLE, WHITE MARKING (Used with Code H or Q on group 4) OR BLACK HANDLE, RED INDICATOR AND MARKING (Used with Code M or R ON group 4 - Two Tone)	Refer to Group 4
W	WHITE HANDLE, BLACK MARKING (Used with Code H or Q on group 4) OR BLACK HANDLE, WHITE INDICATOR AND MARKING (Used with Code M or R ON group 4 - Two Tone)	Refer to Group 4
X	No handle	
Y	YELLOW HANDLE, WHITE MARKING (Used with Code H or Q on group 4) OR BLACK HANDLE, YELLOW INDICATOR AND MARKING (Used with Code M or R ON group 4 - Two Tone)	
Group 17: Handle Marking		
D	I - O and ON - OFF	
H	I - O / ON - OFF and AMP RATING	
I	ON - I marked on Functional handle ,PUSH TO RESET and AMP RATING marked on non-functional handle	
X	Not applicable	
Group 18: Mounting Orientation for Marking		
Code	Description	Comments
1	Breaker mounted in Vertical Axis with LINE at the BOTTOM, Marking reads left to right - normal horizontal	
2	Breaker mounted in Horizontal Axis with LINE at the RIGHT HAND SIDE, Marking reads left to right - normal horizontal	
H	Breaker mounted in Horizontal Axis with LINE at the LEFT HAND SIDE, Marking reads left to right - normal horizontal	
V	Breaker mounted in Vertical Axis with LINE at the TOP, Marking reads left to right - normal horizontal	
X	Not Applicable	
Group 19: Front Plate Marking and Test Button		
Code	Description	Comments
2	Black Front Plate, No Marking, Rocker Handle, Test Button	Applicable to Rocker handle, Use with Group 4, Codes Q and R
B	Black front plate no marking	
Group 20: Inter-phase Barrier and Terminal Cover		
Code	Description	Comments
A	Inter-Phase Barrier-SMALL	
C	Inter-Phase Barrier-Z Type	
Group 21: Approvals (Product Normally Approved to)		
Code	Description	Comments
1	UL recognized UL1077, CUR, IEC/EN60934, CE, UKCA	Normally certified to these certifications
2	UL listed UL489, CUL, IEC/EN60934, CE, UKCA	Normally certified to these certifications
3	UL listed UL489A, CUL, IEC/EN60934, CE, UKCA	Normally certified to these certifications
Group 22: Safety Marks		
Code	Description	Comments
X	Not applicable	
C	GB17701, CCC	

For options not listed, please contact CBI

C-Frame MKIV - Series Circuit Breakers

Mounting Screw Detail

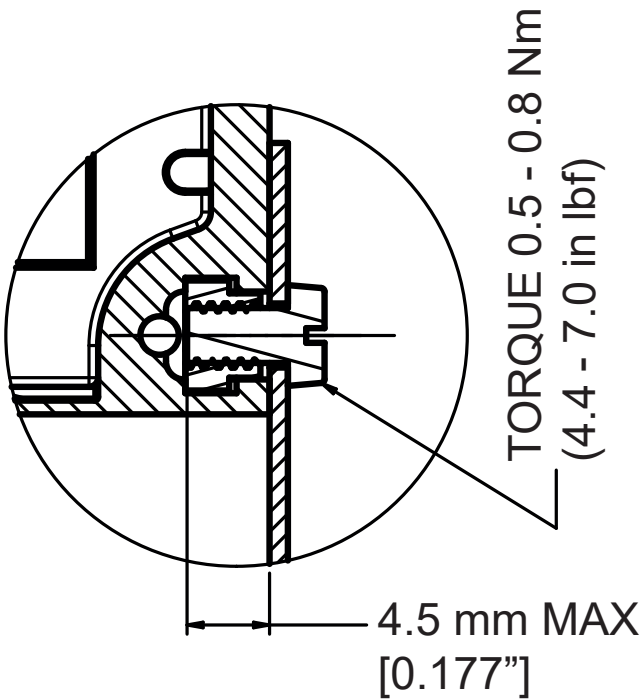

MOUNTING SCREW DETAIL

C-Frame MKIV - Series Circuit Breakers

Outline Dimensions: Standard Handle

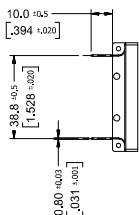
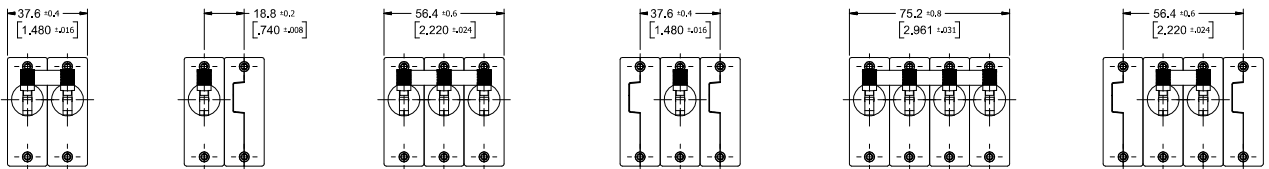
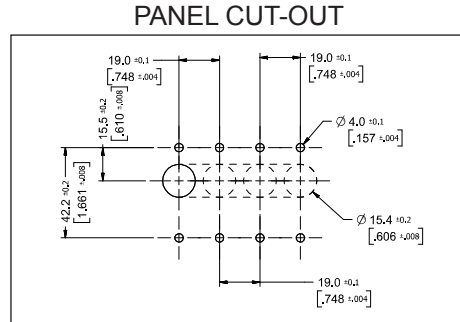
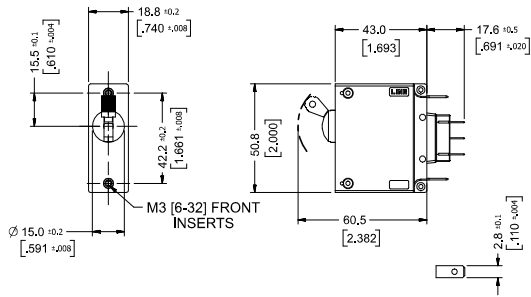

QUICK CONNECT TERMINAL

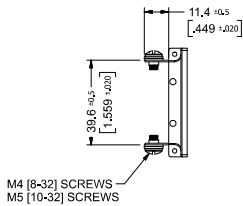

M4 [8-32] SCREWS
M5 [10-32] SCREWS

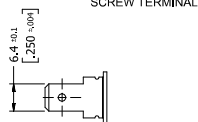

SCREW TERMINAL 30° BENT

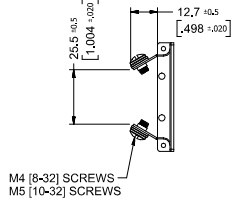

M4 [8-32] SCREWS
M5 [10-32] SCREWS

SCREW TERMINAL 30° BENT

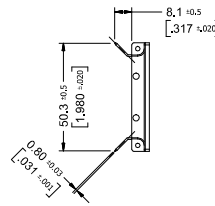

QUICK CONNECT TERMINAL 30° BENT

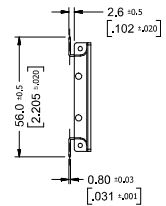

QUICK CONNECT TERMINAL 90° BENT

(DIMENSION IN BRACKETS ARE IN INCH)
TOLERANCE ±0.4 UNLESS OTHERWISE SPECIFIED

C-Frame MKIV - Series Circuit Breakers

Outline Dimensions: Rocker Handle

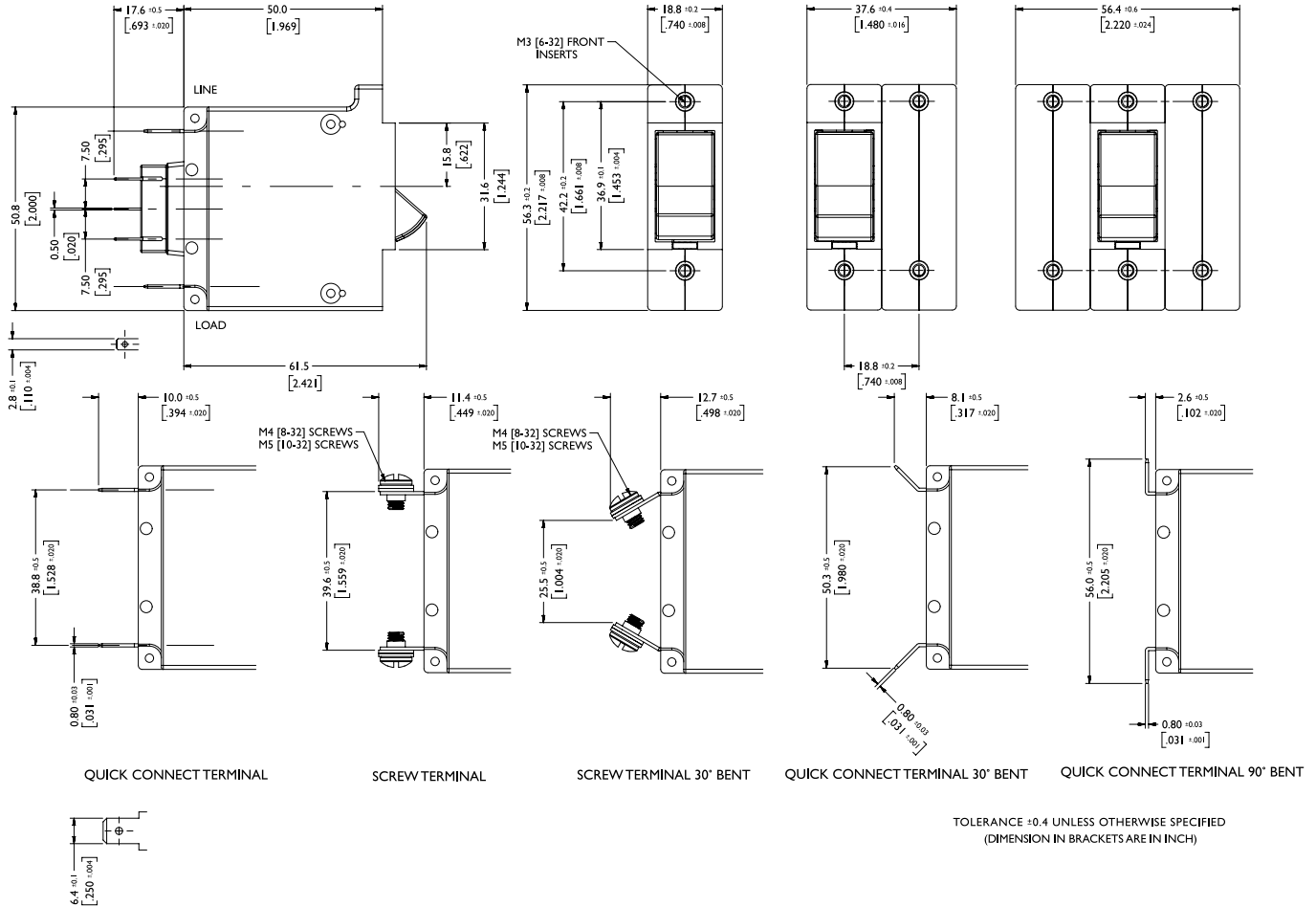

Please review our Customer Terms and Conditions on www.cbi-lowvoltage.co.za

All rights reserved. Unless otherwise indicated, all materials on these pages are copyrighted by CBI (Pty) Ltd. No part of these pages, either text or image may be used for any purpose other than personal use. Therefore, reproduction, modification, storage in a retrieval system or retransmission, in any form or by any means, electronic, mechanical or otherwise, for reasons other than personal use, is strictly prohibited without prior written permission. CBI (Pty) Ltd reserves the right to alter any details of this document without notice and while every effort is made to ensure the accuracy of the content, no warranty is given as to accuracy of this document and no responsibility will be accepted for error or misinterpretation and any resulting loss.

EUROPEAN HEADQUARTER

Emcomp International AB
 Tomtagatan 17
 702 32, Örebro, Sweden
 Tel: +46 (0)581 62 15 50
 Fax: +46 (0)581 62 15 60
 Email: info@emcomp.se
 Website: www.emcomp.se

GERMANY OFFICE

Emcomp International AB
 Gewerbepark 23
 85250 Altomünster Germany
 Tel: +49 8254 994 334 10
 Fax: +49 8254 994 334 19
 Email: info@emcomp.se
 Website: www.emcomp.de